

### ACADEMIC PATENTING IN EUROPE: DATABASE SHARING, APPLICATIONS AND EXTENSIONS (APE-INV)

Standing Committee for the Social Sciences (SCSS)

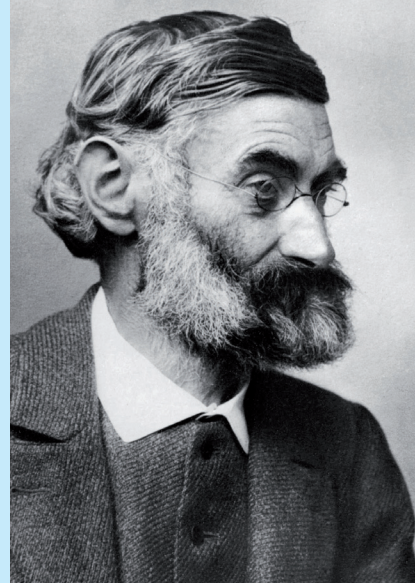

Patent Number 23,570 Kelvin and James White Ltd, 1907  
An Improved Compass Suspension for use on board ship

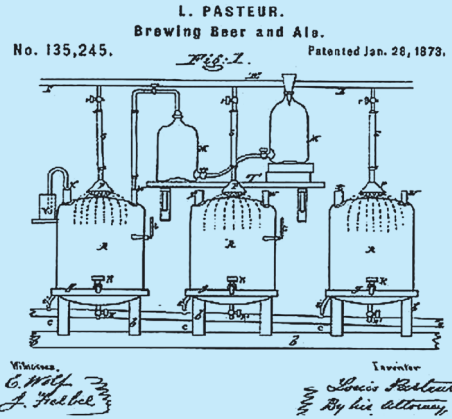
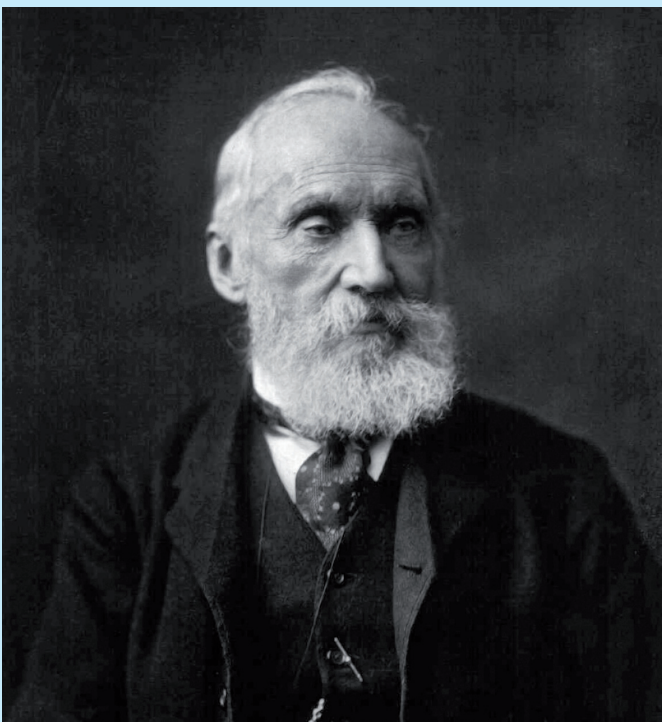
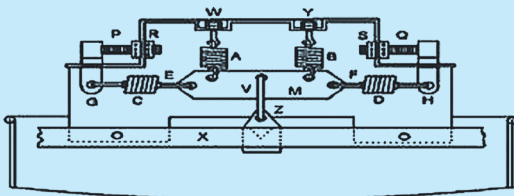

MONTECATINI	Opposto: <b>AVVISO</b>	Stato: ITALIA
DIREZIONE CENTRALE DEI AFFARI GENERALI E BREVETTI SERVIZI BREVETTI	<b>Deposito Domanda Brevetto in:</b>	Nr. rif.: U.647
Argomento:	Copolimeri ad innesto di cloruro di vinilidene e gomme naturali u/o sintetiche.	Eventuale rif. Scenzione
	FC/dl	
Su Vostro incarico, abbiamo depositato la domanda di brevetto, di cui Vi diamo gli estremi provvisori. Vi terremo al corrente dell'ulteriore svolgimento della pratica.		
Titolare: MONTECATINI EDISON S.p.A. - Milano -		



---

## Introduction

---

The European Science Foundation (ESF) is an independent, non-governmental organisation, the members of which are 79 national funding agencies, research performing agencies, academies and learned societies from 30 countries.

The strength of ESF lies in the influential membership and in its ability to bring together the different domains of European science in order to meet the challenges of the future.

Since its establishment in 1974, ESF, which has its headquarters in Strasbourg with offices in Brussels and Ostend, has assembled a host of organisations that span all disciplines of science, to create a common platform for cross-border cooperation in Europe.

ESF is dedicated to promote collaboration in scientific research, funding of research and science policy across Europe. Through its activities and instruments ESF has made major contributions to science in a global context. The ESF covers the following scientific domains:

- Humanities
- Life, Earth and Environmental Sciences
- Medical Sciences
- Physical and Engineering Sciences
- Social Sciences
- Marine Sciences
- Materials Science and Engineering
- Nuclear Physics
- Polar Sciences
- Radio Astronomy
- Space Sciences

Cover pictures:

Louis Pasteur Portrait (from <http://it.wikipedia.org>) – Louis Pasteur Patent (from <http://patentpending.blogspot.com>); Ernst Abbe Portrait ([http://it.wikipedia.org/wiki/Ernst\\_Abbe](http://it.wikipedia.org/wiki/Ernst_Abbe)) – Ernst Abbe Patent Application Microscope (<http://www.zeiss.de>); William Thomson (Lord Kelvin) Portrait (from <http://it.wikipedia.org>) – William Thomson Patent Application (from University of Glasgow website [http://www.physics.gla.ac.uk/Physics3/Kelvin\\_online/Kelvin\\_society/society.htm](http://www.physics.gla.ac.uk/Physics3/Kelvin_online/Kelvin_society/society.htm)); Giulio Natta Portrait (© Archivio Giulio Natta 2008 <http://www.giulionatta.it>) – Giulio Natta Patent Application By Montecatini (© Archivio Giulio Natta 2008 <http://www.giulionatta.it>).

Academic patenting is an important part of the larger phenomenon of university-industry technology transfer. In particular, patents are a key tool for protecting inventions and foster innovation in a number of science-based technologies, such as chemicals, pharmaceuticals, biotech and many fields of electronics, to which academic scientists contribute both indirectly, by widening their science base, and directly, by producing inventions susceptible of industrial application, and therefore of patent protection.

Measuring the extent of the phenomenon of academic patenting, and studying its determinants, can improve our understanding of university-industry relationships and their influence on academic researchers' strategic choices of scientific targets and norms of conduct.

The Academic Patenting in Europe: Database sharing, applications and extensions (APE-INV) programme builds its activities on an historical and institutional premise, namely that most European universities have long been prevented from getting involved in IPR management, or have themselves resisted such involvement, either for legal, administrative or cultural reasons. As a consequence, they hardly appear in official statistics as patent applicants or grantees. It is only by re-classifying patents by inventors, and by discovering whether such inventors belong to the academic research system, that it becomes possible to measure the number and importance of the inventions produced by the system itself.

Cleaning and standardising inventors' names and addresses, as well as matching them to academic scientists' names and affiliations, is a scientific enterprise of vast proportions which poses many practical and methodological challenges. It can be successful only if supported by international cooperation. The APE-INV programme aims at making that cooperation possible. Its outcome will be the creation of a research network whose participants will share existing data, software and expertise, and produce more when needed. The most tangible output of this cooperative effort will be the first European database of academic patents, one that will allow for cross-country comparisons and for a number of thematic enquiries, on issues such as the value of academic patents, the social ties between academic and non-academic inventors, the mobility of inventors in space and across organisations, and the relationship between patents, scientific advancements and publications.

The running period of the ESF Research Networking Programme APE-INV is four years, from June 2009 to September 2013.

# Background

The issue of university patenting has moved to the forefront of economic analysis due to the impressive growth registered in the number of patent applications by US universities during the 1980s. Compared to the US, European research on academic patenting is much more recent. The largest part of it has dealt with the institutional differences between the European and the US academic systems. Among these institutional differences, two are of particular interest:

- The legal ownership of IPRs over academic research, epitomised by the so-called “professor’s privilege”, which exempts academic personnel from attributing the rights over their inventions to their employers;
- The European universities’ limited expertise in self-financing and IPR management, which follows from a tradition of reliance on governmental regulation and block grant funding.

The professor’s privilege used to be a typical institution in Germany, Austria and the Scandinavian countries. Policy concerns over the little use professors made of it have recently led to its abolition in all countries but Sweden. More generally, most European universities have long been prevented from, or have themselves resisted, being involved in IPR management, thus leaving patent matters in their scientists’ or research sponsors’ hands. It is only recently that European universities have changed attitude, also in response to changes in legislation. Still, most patents covering inventions by academic scientists belong to business companies or, to a lesser extent, individual scientists and governmental funding agencies. As a consequence, official statistics, which classify patents according to the identity of the grantees or applicants (not of the inventors), largely underestimate the number of European academic patents.

Following this clue, different recent studies have re-classified patents by inventor, and matched the inventors’ names with those of university faculties, thus producing the first estimates of academic patenting in some European countries (for instance, Finland, Italy, Norway, France, The Netherlands and Sweden).

In all of these countries a significant percentage of domestic patent applications at the European Patent Office is found to cover inventions of academic scientists, so that the gap between US and European universities in terms of contribution to patenting turns out not to be as big as it seems by looking only at universities’ patent portfolios.

Ongoing European research is now focusing on whether the different property regime of academic patents affects their commercial value and exploitation possibilities. Additional research lines aim at investigating:

- the impact of involvement in patenting activity on academic scientists’ scientific performance, as measured

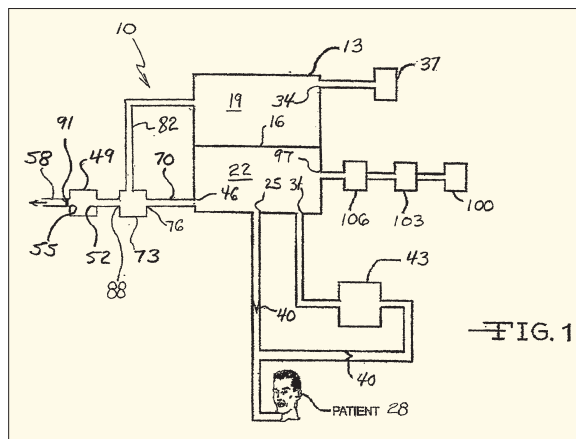

**Figure 1.** Breathing-gas delivery system with exhaust gas filter body and method of operating a breathing gas delivery system (PCT patent, publ nr WO2008138014; applicant: The Research Foundation, SUNY)

- by the number, quality and basic science contents of publications;
- the economic incentives of academic inventors, mainly on the basis of surveys;
- the social ties and knowledge exchanges taking place between academic and non-academic inventors;
- the effects of the abolition of the professor’s privilege.

# Objectives and Programme Approach

The main results expected by APE-INV are:

## Sharing experiences for the creation of an INV Database

- to share expertise and methods among European (and US or Japanese) researchers for the creation of an inventors' database, one that will identify all different spelling variations of the inventor's name, as well as the inventor's different addresses and patents;
- to share expertise and methods among European researchers for matching the inventors' database with national databases of academic scientists, in order to produce comparable counts of academic patenting activity and to collect auxiliary information on academic inventors.

## Producing a Database on Academic Patenting in Europe (APE-INV Database)

- to produce a freely-available database on "academic patenting in Europe", that will contain reliable and comparable information on the contribution of European academic scientists to technology transfer via patenting, and which researchers will be able to update in the future.

## Editing joint publications using the dataset

- to experiment with the database opportunities, editing one or more joint publications containing original applications of the newly-created databases.

## Designing a method to allow users to correct data

- to devise a method for collecting the database users' feedback on the quality of the data, one that will allow users to enter their own corrections to the identification errors. Users' corrections are particularly important in this case, since the identification of inventors relies on algorithms that make use of information on each inventor's social network: so users' corrections to the identity of one inventor may lead to correcting the identity of others.

## Cooperating with established institutions in the field of patent data

- A unique window of opportunity has recently been opened by the European Patent Office (EPO) and its collaboration with the OECD Patent Statistics Task Force for the creation of PATSTAT, a new database for statistical use (jointly with WIPO, the World Intellectual Property Organization, and Eurostat). The APE-INV programme will contribute to creating a community of PATSTAT users and to turning PATSTAT into a reference source for the worldwide community of social scientists engaged in science and technology studies. Besides making use of PATSTAT data, APE-INV will try to establish cooperative ties with all the institutions involved in its development.

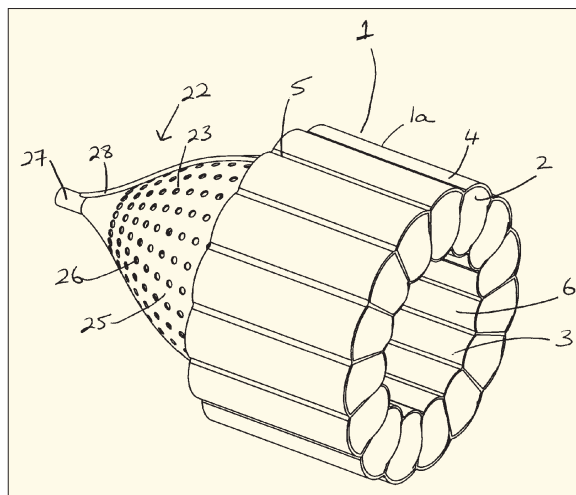

**Figure 2.** Intravascular devices and balloons for use therewith (EPO patent, publ nr EP2241284, applicant: National University of Ireland)

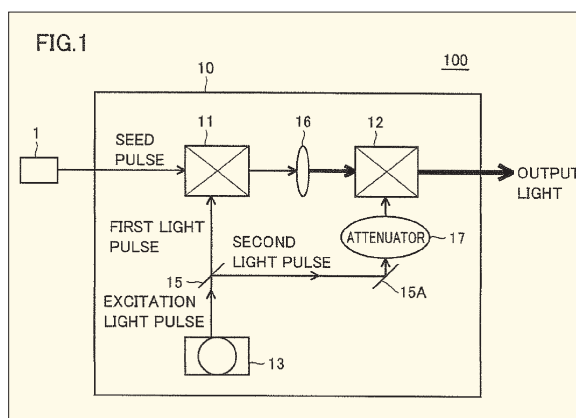

**Figure 3.** Optical amplifier (EPO patent, publ nr EP2242151; applicant: Kyoto University)

## Activities

---

The activities of the APE-INV programme will cover a period of four years.

### Expert workshops

These smaller meetings will bring together mainly senior researchers in order to define and implement the construction of the database, the creation of a number of working groups on issues such as data cleaning, collection/harmonisation of data on academic personnel, identifying the procedures for remote access, for the corrections and a set of IPR arrangements for sharing among participants and for general access/diffusion.

These short meetings (one to two days) will focus on the technical issues and methodological convergence. The latter will be critical for allowing data collection and integration. For this reason the APE-INV programme will focus on Technical Workshops in the two first years of activity.

### Conferences

Two conferences will be held in the last two years of the programme in order to share the results and disseminate the use of the APE-INV Database. The *final conference* will be organised specifically in order to present the APE database, the joint publications, and ongoing work on networks of inventors, inventors' mobility and other inventor-related issues to which the APE can contribute.

### Exchange visits and short visits

The ESF APE-INV programme will foster researchers' mobility at European and, if possible, at international level through exchange visit grants. Junior researchers, experienced researchers and senior scholars will have access to such facilities.

Visits will be both long (one month) and short (one to two weeks). Each year a call for expressions of interest will be published.

### Publications

A key objective is the publication of a series of papers collecting the results achieved using the data of the APE-INV Database. APE participants and other scientists making use of the database will be asked to acknowledge the use of the database in their papers.

## Funding

---

ESF Research Networking Programmes are principally funded by the Foundation's Member Organisations on an *à la carte* basis. APE-INV is supported by:

- **Fonds zur Förderung der wissenschaftlichen Forschung in Österreich (FWF)**  
*Austrian Science Fund, Austria*
- **Fonds de la Recherche Scientifique (FNRS)**  
*Fund for Scientific Research, Belgium*
- **Fonds voor Wetenschappelijk Onderzoek-Vlaanderen (FWO)**  
*Research Foundation Flanders, Belgium*
- **Nacionalna zaklada za znanost, visoko školstvo i tehnološki razvoj Republike Hrvatske (NZZ)**  
*The National Foundation of Science, Higher Education and Technological Development of the Republic of Croatia, Croatia*
- **Det Frie Forskningsråd – Samfund og Erhverv (FSE)**  
*The Danish Council for Independent Research – Social Sciences, Denmark*
- **BETA (Bureau d'Économie Théorique et Appliquée, CNRS), France**
- **Deutsche Forschungsgemeinschaft (DFG)**  
*German Research Foundation, Germany*
- **Consiglio Nazionale delle Ricerche (CNR)**  
*National Research Council, Italy*
- **Nederlandse Organisatie voor Wetenschappelijk Onderzoek (NWO)**  
*Netherlands Organisation for Scientific Research, The Netherlands*
- **Consejo Superior de Investigaciones Científicas (CSIC)**  
*Council for Scientific Research, Spain*
- **Vetenskapsrådet (VR)**  
*Swedish Research Council, Sweden*
- **Schweizerischer Nationalfonds (SNF)**  
*Swiss National Science Foundation, Switzerland*

However, APE-INV is willing to enlarge participation to other countries, in order to become a pan-European research networking programme. In addition, collaboration with scientists worldwide is encouraged, and will be pursued with the help of subsidiary funds.

Presently, a number of leading researchers from Europe and the US have expressed interest and made themselves available for cooperation with the APE-INV programme. A non-exhaustive list includes Aldo Geuna (University of Turin, Italy, and SPRU-Sussex University, UK); Nicolas Carayol (Université de Bordeaux, France); Jacques Mairesse (CREST-INSEE, France); Bronwyn Hall (UC Berkeley and NBER, US); Paula Stephan (Georgia State University, US); Marie and Jerry Thursby (Georgia Tech and NBER, US); Dominique Guellec (OECD; formerly Chief Economist of the European Patent Office).

# APE-INV Steering Committee

---

**Professor Francesco Lissoni**  
(Chair)  
CESPRI – Centre for Research on  
Innovation and Internationalisation  
Department of Economics  
Università Commerciale  
“L. Bocconi”  
via Sarfatti 25  
20136 Milano • Italy  
Tel: +39 02 58363370  
Fax: +39 02 58363399  
Email: francesco.lissoni@  
unibocconi.it

**Dr Karin Hoisl**  
School of Management  
Ludwig-Maximilian University  
Munich  
Kaulbachstr.45 II  
80539 Munich • Germany  
Email: hoisl@bwl.uni-muenchen.de

**Dr Catalina Martínez García**  
Centro de Ciencias Humanas  
y Sociales  
Instituto de Políticas y Bienes  
Públicos (IPP) – CSIC  
Albasanz, 26-28  
28037 Madrid • Spain  
Email: catalina.martinez@  
cchs.csic.es

**Professor Stephane Lhuillery**  
CDM ILEMT CEMI  
École Polytechnique Fédérale  
de Lausanne  
ODY 1 18 (Odyssea) • Station 5  
1015 Lausanne • Switzerland  
Email: stephane.lhuillery@epfl.ch

**Professor Peter Lotz**  
Department of Innovation and  
Organizational Economics  
Copenhagen Business School  
Solbjergvej 3, 3<sup>rd</sup> floor  
2000 Frederiksberg • Denmark  
Tel: +45 3815 2554  
Fax: +45 3815 2540  
Email: pl.ivs@cbs.dk

**Professor Maureen McKelvey**  
Department of Business  
Administration/Industrial  
and Financial Management  
School of Business, Economics  
and Law  
Gothenburg University  
PO Box 610  
405 30 Gothenburg • Sweden  
Email: maureen.mckelvey@  
handels.gu.se

**Dr Sonja Radas**  
The Institute of Economics  
Trg. J.F. Kennedy 7  
10000 Zagreb • Croatia  
Email: sradas@eizg.hr

**Professor Secondo Rolfo**  
Ceris-CNR  
Via Real Collegio, 30  
10024 Moncalieri TO • Italy  
Tel: +39 011 6824 913  
Fax: +39 011 6824 966  
Email: s.rolfo@ceris.cnr.it

**Professor Christian Stummer**  
Department of Business  
Administration  
Faculty of Business, Economics  
and Statistics  
University of Vienna  
Brünnerstr. 72  
1210 Vienna • Austria  
Tel: +43 1 4277 38146  
Fax: +43 1 4277 38144  
Email: christian.stummer@  
univie.ac.at

**Dr Bart Van Looy**  
MSI  
Faculty of Economics  
and Applied Economics  
Katholieke Universiteit Leuven  
Naamsestraat 69 — bus 3500  
3000 Leuven • Belgium  
Tel: +32 16 32 69 01  
Email: bart.vanlooy@  
econ.kuleuven.be

**Professor Bruno Van  
Pottelsberghe de la Potterie**  
Solvay Business School  
Université Libre de Bruxelles  
CP-145/0  
50 avenue F.D. Roosevelt  
1050 Bruxelles • Belgium  
Email: bruno.vanpottelsberghe@  
ulb.ac.be

**Professor Bart Verspagen**  
Department of Economics  
Maastricht University  
PO Box 616 • 6200 MD Maastricht  
The Netherlands  
Tel: +31 43 38883691  
Email: b.verspagen@  
algec.unimaas.nl

---

## **Programme Coordinator**

**Dr Michele Pezzoni**  
KITeS/CESPRI  
Università Commerciale “L.Bocconi”  
via Sarfatti 25 • 20136 Milano • Italy  
Tel: +39 02 58363393  
Email: michele.pezzoni@tin.it

---

## **ESF Liaison**

**Dr Rifka Weehuizen**  
*Science*

**Ms Céline Ottenwelter**  
*Administration*

Social Sciences Unit  
European Science Foundation  
1 quai Lezay-Marnésia  
BP 90015  
67080 Strasbourg Cedex • France  
Tel: +33 (0)3 88 76 71 19  
Fax: +33 (0)3 88 37 05 32  
Email: cottenwelter@esf.org

For the latest information on this  
Research Networking Programme  
consult the APE-INV website:  
**[www.esf.org/appe-inv](http://www.esf.org/appe-inv)**